

Door Construction:

Raised Panel Profile

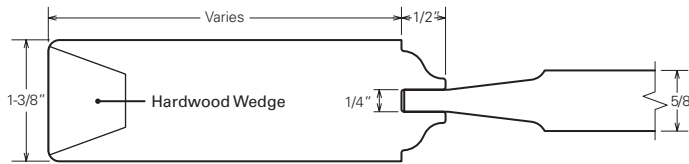

Flat Panel Profile

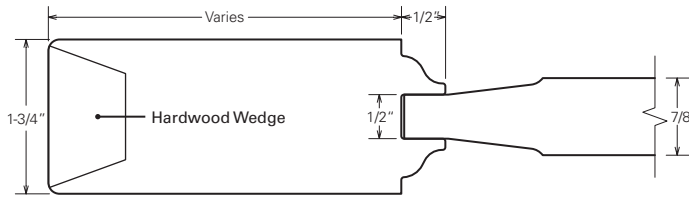
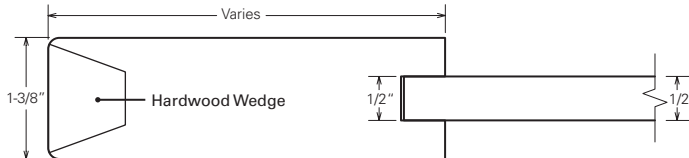
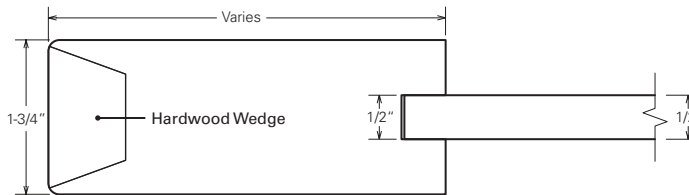
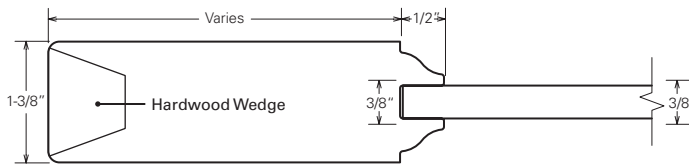

Product Features & Specifications:

Thickness	1-3/8" or 1-3/4"
Maximum Size	Single: 4'0 x 8'0 Pair: 8'0 x 8'0 <i>Taller sizes available on a custom basis</i>
Door Material	Solid MDF
Construction Method	Stile and rail
Finish	Factory Prime
Available Styles	Any standard or custom design that meets the specifications described in this document. <i>See TruStile catalog for all standard styles</i>
Available Profiles	10 standard sticking options 4 standard panel options Custom options also available <i>See TruStile catalog for more details</i>
Panel Construction	
Raised Panel Thickness	5/8" or 7/8"
Flat Panel Thickness	3/8" or 1/2"

Panel Size	
Minimum Panel Size	No minimum
Maximum Panel Size	No minimum
Stock Dimensions	
Top Rail	5"
Bottom Rail	8-1/4" <i>Can be built larger to meet ADA requirements</i>
Stiles	Varies based on size and style
Acoustic Rating	Up to 34 STC rating
Standards	ASTM E-152, NFPA 80, NFPA 252, UBC7-2-1997/UL10C, UBC7-2-1997/UL10B
Hardware Configurations	Pursuant to NFPA80, consult factory for approved configurations
Warranty	Limited lifetime warranty

* For more information visit the TruStile website at: www.trustile.com or call 888.286.3931
Specifications are subject to change. Confirm with TruStile before ordering.

Door Construction:

Raised Panel Profile

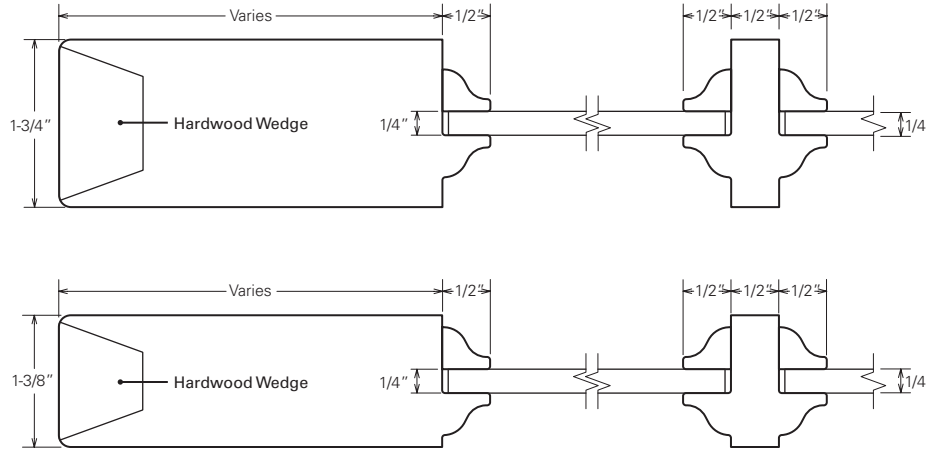

Product Features & Specifications:

Thickness	1-3/8" or 1-3/4"
Maximum Size	Single: 4'0 x 8'0 Pair: 8'0 x 8'0 <i>Taller sizes available on a custom basis</i>
Door Material	Solid MDF
Construction Method	Stile and rail
Finish	Factory Prime
Available Styles	Any standard or custom design that meets the specifications described in this document. <i>See TruStile catalog for all standard styles</i>
Available Profiles	8 standard sticking options 4 standard panel options Custom options also available <i>See TruStile catalog for more details</i>
Maximum Glass Size	Varies based on size and style
Panel Construction	<i>doors with combined panel & glass</i>
Raised Panel Thickness	5/8" or 7/8"
Flat Panel Thickness	3/8" or 1/2"

Panel Size	<i>doors with combined panel & glass</i>	
Minimum Panel Size		No minimum
Maximum Panel Size		No minimum
Stock Dimensions		
Top Rail		5"
Bottom Rail		8-1/4" <i>Can be built larger to meet ADA requirements</i>
Stiles		Varies based on size and style
Acoustic Rating		N/A
Standards		ASTM E-152, NFPA 80, NFPA 252, UBC7-2-1997/UL10C, UBC7-2-1997/UL10B
Hardware Configurations		Pursuant to NFPA80, consult factory for approved configurations
Warranty		Limited lifetime warranty

* For more information visit the TruStile website at: www.trustile.com or call 888.286.3931
Specifications are subject to change. Confirm with TruStile before ordering.

Door Construction:

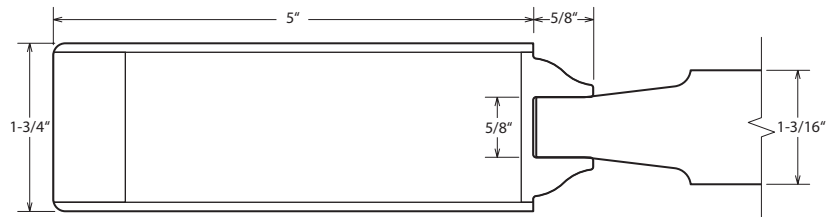

Product Features & Specifications:

Thickness	1-3/4"	Panel Size	
Maximum Size	Single: 4'0 x 8'0 Pair: 8'0 x 8'0 <i>Taller sizes available on a custom basis</i>	Minimum Panel Size	No minimum
Door Material	MDF with engineered stiles and rails	Maximum Panel Size	No maximum
Construction Method	Stile and rail	Maximum Glass Size	N/A
Finish	Factory Prime	Stock Dimensions	
Available Styles	Any standard or custom design that meets the specifications described in this document. <i>See TruStile catalog for all standard styles</i>	Top Rail	5"
Available Profiles	10 standard sticking options 4 standard panel options Custom options also available <i>See TruStile catalog for more details</i>	Bottom Rail	8-1/4" <i>Can be built larger to meet ADA requirements</i>
Panel Construction <i>doors with combined panel & glass</i>		Stiles	5" minimum
Raised Panel Thickness	1-3/16"	Acoustic Rating	Up to 34 STC rating
Flat Panel Thickness	11/16"	Standards	ASTM E-152, NFPA 80, NFPA 252, UBC7-2-1997/UL10C, UBC7-2-1997/UL10B
		Hardware Configurations	Pursuant to NFPA80, consult factory for approved configurations
		Warranty	Limited lifetime warranty

* For more information visit the TruStile website at: www.trustile.com or call 888.286.3931
Specifications are subject to change. Confirm with TruStile before ordering.

Door Construction:

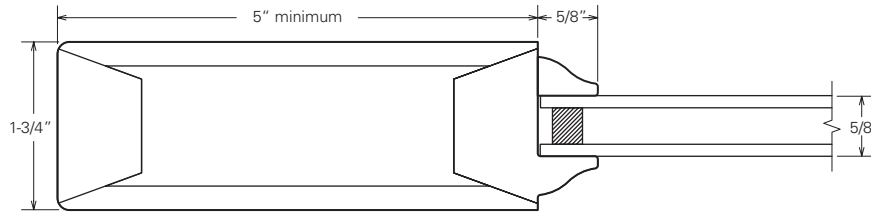

Product Features & Specifications:

Thickness	1-3/4"	Panel Size	
Maximum Size	Single: 4'0 x 8'0 Pair: 8'0 x 8'0 <i>Taller sizes available on a custom basis</i>	<i>doors with combined panel & glass</i>	
Door Material	MDF with engineered stiles and rails	Minimum Panel Size	No minimum
Construction Method	Stile and rail	Maximum Panel Size	No maximum
Finish	Factory Prime	Maximum Glass Size	N/A
Available Styles	Any standard or custom design that meets the specifications described in this document. <i>See TruStile catalog for all standard styles</i>	Stock Dimensions	
Available Profiles	10 standard sticking options 4 standard panel options Custom options also available <i>See TruStile catalog for more details</i>	Top Rail	5"
Panel Construction		Bottom Rail	8-1/4" <i>Can be built larger to meet ADA requirements</i>
<i>doors with combined panel & glass</i>		Stiles	5"
Raised Panel Thickness	1-3/16"	Acoustic Rating	N/A
Flat Panel Thickness	11/16"	Standards	ASTM E-152, NFPA 80, NFPA 252, UBC7-2-1997/UL10C, UBC7-2-1997/UL10B
		Hardware Configurations	Pursuant to NFPA80, consult factory for approved configurations
		Warranty	Limited lifetime warranty

* For more information visit the TruStile website at: www.trustile.com or call 888.286.3931
Specifications are subject to change. Confirm with TruStile before ordering.



Limited Lifetime Warranty Interior MDF Doors

What This Warranty Covers. TruStile Doors Inc. (TruStile) warrants to the original buyer of a TruStile MDF Door specifically for interior purposes (the "Product") that the Product shall:

- 1) Comply with the WDMA Industry Standard I.S.-6 (in effect as of the date of manufacture of the Product) pertaining to Measurements, Tolerances and Warp; and
- 2) Be free from defects in materials and workmanship, including delamination.

This Warranty Does Not Cover:

- 1) Any Product that is purchased from the manufacturer without the factory prime coat.
- 2) Any Product that is over three-feet six-inches (3'6") in width and/or eight-feet (8') in height.
- 3) Warp not exceeding ¼" in the plane of the door itself for doors three-feet (3') X seven-feet (7') or smaller. For doors larger than three-feet (3') X seven-feet (7'), warp not exceeding 3/8" in the plane of the door itself.
- 4) Damage caused by attempts other than TruStile to repair the Product.
- 5) Product failure due to improper installation.
- 6) Damage caused by failure to comply with the finishing, handling or care instructions provided by TruStile. Including but not limited to damage caused by improper handling or on-site storage.
- 7) Damage due to trimming more than one-inch (1") total of the Product.
- 8) Damage caused by failing to seal all six (6) sides of the Product. All edges must be sealed immediately after fitting and hanging with the integrity of the finish maintained.
- 9) Defects caused by bow or nonalignment in the frame or jamb in which the door is hung or improper hanging.
- 10) Damage due to failure to perform normal owner's maintenance, including maintaining the finish (factory or non-factory finish).
- 11) Variations or unsatisfactory results in gloss level, texture or appearance resulting from the field application of paint or other finishing material.
- 12) Slight expansion due to differing environmental conditions.
- 13) Damage caused by others or by any cause beyond the control of TruStile, including but not limited to, damage caused by normal wear and tear; customer misuse, abuse, neglect or alteration; or, fire, flood, earthquake, storm, tornado or other acts of nature.
- 14) Doors shipped out of the continental US, Hawaii or Canada.

How Long The Warranty Lasts and What TruStile Will Do. Should the Product fail to conform to this warranty within a period of ten (10) years from the date of purchase of the Product, TruStile will, at its option, (a) repair the Product, (b) replace the Product in the same stage of fitting or finishing as was initially supplied by TruStile, or (c) refund the price originally paid to TruStile for the Product. After ten (10) years from the date of purchase of the Product, should the Product fail to conform to this warranty, you may purchase a new door similar to the Product at fifty-percent (50%) of the current retail cost of such door.

If the claimed nonconformity is warp, TruStile may defer repairing or replacing the Product for a period of up to twelve (12) months from the latter of the date of claim or the date of installation, as it is not uncommon for a temporary warp condition to occur as the door adjusts to local weather conditions. This deferral will not be counted against the warranty period.

What TruStile Will Not Do. TruStile is not responsible for transportation, shipping, removal, finishing, labor or installation charges or costs incurred in replacing the Product or any other costs relating to the replacement of the Product.

In addition, TruStile shall not be responsible for indirect, consequential or incidental damages. Some states do not allow the exclusion or limitation of incidental or consequential damages, so the above limitation may not apply to you.

How to Get Service. Claims under this warranty must be made in writing, with proof of purchase and prior to any repair work, to: TruStile Doors Inc., 1780 East 66th Ave., Denver, CO 80229. TruStile reserves the right and must be given a thirty (30) day opportunity to have a TruStile representative field inspect the Product.

How State Law Applies. This warranty gives you specific legal rights, and you may also have other rights, which vary from state to state. Some states do not allow limitations on how long an implied warranty lasts, so the above limitation may not apply to you. TruStile shall not be responsible for indirect, consequential or incidental damages, or for any amount in excess of the purchase price of the defective Product, whether the claim is for breach of warranty or negligence. Some states do not allow the exclusion or limitation of incidental or consequential damages, so the above limitation or exclusion may not apply to you.

This warranty sets forth TruStile's maximum liability for the Products. TruStile makes no other warranty, expressed or implied with respect to its Product. No distributor, vendor or TruStile representative has the permission to alter this warranty.



Limited Lifetime Warranty Exterior MDF Doors

What This Warranty Covers. TruStile Doors Inc. (TruStile) warrants to the original buyer of a TruStile MDF Door specifically for exterior purposes (the "Product") that the Product shall:

- 1) Comply with the WDMA Industry Standard I.S.-6 (in effect as of the date of manufacture of the Product) pertaining to Measurements, Tolerances and Warp; and
- 2) Be free from defects in materials and workmanship.

This Warranty Does Not Cover:

- 1) Any TruStile Door that is over three-feet six-inches (3'6") in width and/or eight-feet (8') in height.
- 2) Warp not exceeding 1/4" in the plane of the door itself for doors three-feet (3') X seven-feet (7') or smaller. For doors larger than three-feet (3') X seven-feet (7'), warp not exceeding 3/8" in the plane of the door itself.
- 3) Damage caused by attempts other than TruStile to repair the Product.
- 4) Damage caused by not providing adequate protection from the elements. Adequate protection includes, but is not limited to an overhang extending out a least one-half the distance from the bottom of the door to the bottom of where the overhang begins and extending at least 3 feet past either side of opening. More overhang may be necessary in areas with extreme weather conditions to adequately protect the door. Proper overhang significantly decreases the chance of warping, checking and delamination caused by the sun and precipitation.
- 5) Product failure due to improper installation.
- 6) Damage caused by failure to comply with the finishing, handling or care instructions provided by TruStile. Including but not limited to damage caused by improper handling or on-site storage.
- 7) Damage due to trimming more than one-inch (1") total of the Product.
- 8) Damage caused by failing to seal all six (6) sides and hardware cutouts of the Product. All edges must be sealed immediately after fitting and hanging with the integrity of the finish maintained.
- 9) Defects caused by bow or nonalignment in the frame or jamb in which the door is hung or improper hanging.
- 10) Damage due to failure to perform normal owner's maintenance, including maintaining the finish (factory or non-factory finish).
- 11) Variations or unsatisfactory results in gloss level, texture or appearance resulting from the field application of paint or other finishing material.
- 12) Slight expansion due to differing environmental conditions.
- 13) Damage caused by temperature buildup where a storm door is utilized.
- 14) Damage caused by others or by any cause beyond the control of TruStile, including but not limited to, damage caused by normal wear and tear, weathering (including corrosion of components in seacoast applications); customer misuse, abuse, neglect or alteration; or, fire, flood, earthquake, storm, tornado or other acts of nature.
- 15) Doors shipped out of the continental US, Hawaii or Canada.

How Long The Warranty Lasts and What TruStile Will Do. Should the Product fail to conform to this warranty within a period of five (5) years from the date of purchase of the Product, TruStile will, at its option, (a) repair the Product, (b) replace the Product in the same stage of fitting or finishing as was initially supplied by TruStile, or (c) refund the price originally paid to TruStile for the Product. After five (5) years from the date of purchase of the Product, should the Product fail to conform to this warranty, you may purchase a new door similar to the Product at fifty-percent (50%) of the current retail cost of such door.

If the claimed nonconformity is warp, TruStile may defer repairing or replacing the Product for a period of up to twelve (12) months from the latter of the date of claim or the date of installation, as it is not uncommon for a temporary warp condition to occur as the door adjusts to local weather conditions. This deferral will not be counted against the warranty period.

What TruStile Will Not Do. TruStile is not responsible for transportation, shipping, removal, finishing, labor or installation charges or costs incurred in replacing the Product or any other costs relating to the replacement of the Product. In addition, TruStile shall not be responsible for indirect, consequential or incidental damages. Some states do not allow the exclusion or limitation of incidental or consequential damages, so the above limitation may not apply to you.

How to Get Service. Claims under this warranty must be made in writing, with proof of purchase and prior to any repair work, to: TruStile Doors Inc., 1780 East 66th Ave., Denver, CO 80229. TruStile reserves the right and must be given a thirty (30) day opportunity to have a TruStile representative field inspect the Product.

How State Law Applies. This warranty gives you specific legal rights, and you may also have other rights, which vary from state to state. Some states do not allow limitations on how long an implied warranty lasts, so the above limitation may not apply to you. TruStile shall not be responsible for indirect, consequential or incidental damages, or for any amount in excess of the purchase price of the defective Product, whether the claim is for breach of warranty or negligence. Some states do not allow the exclusion or limitation of incidental or consequential damages, so the above limitation or exclusion may not apply to you.

This warranty sets forth TruStile's maximum liability for the Products. TruStile makes no other warranty, expressed or implied with respect to its Product. No distributor, vendor or TruStile representative has the permission to alter this warranty.