

Hinge Types other specialty hinge applications available

Full Mortise

One leaf is MORTISED in the DOOR edge, the other leaf is MORTISED in the JAMB. This is the most common hinge application.

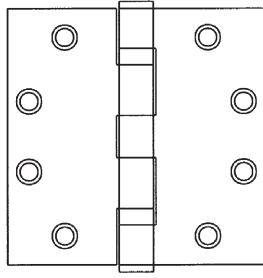

Wide Throw

The WIDTH of the hinge is increased (i.e. 4.5" x 6"), moving the barrel away from the face of the door. Used when additional THROW is required to clear trim or wall conditions. Full Mortise Only.

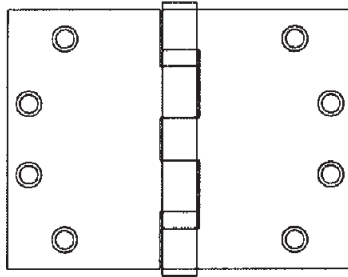

Half Mortise

One leaf is MORTISED in the DOOR edge, the other leaf is applied to the SURFACE (face) of the JAMB. Used when conditions prevent the jamb leaf from being mortised.

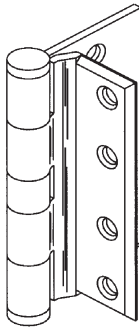

Full Surface

One leaf is applied to the SURFACE (face) of the DOOR; the other leaf is applied to the SURFACE (face) of the JAMB. Used when conditions prevent both hinge leaves from being mortised.

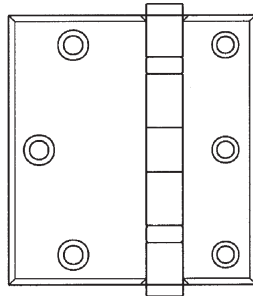

Half Surface

One leaf is applied to the SURFACE (face) of the DOOR, the other leaf is MORTISED in the JAMB. Used when conditions prevent the door leaf from being mortised.

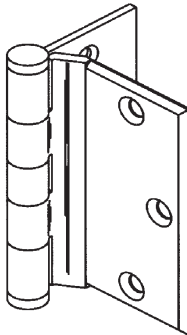

Swing Clear

The hinge leaves are formed to locate the barrel in a position that allows the door to SWING CLEAR of the opening when opened to 90 degrees. This permits hospital beds, wheelchairs etc. to pass through the opening without hitting the hinge edge of the door.

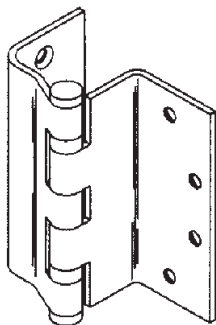

Anchor

The hinge leaves are mortised in the door and jamb at the top corner, ANCHORING the door in the jamb. Provides reinforcement and support at the top corner where stress can occur due to high frequency service. Full Mortise only.

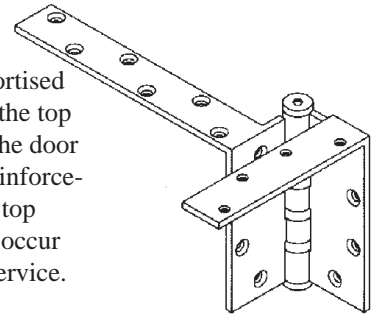

Raised Barrel

Both hinge leaves are offset to RAISE the BARREL off the jamb, allowing the door to swing without the knuckles rubbing on the jamb. Used when a door is set deep into a wide frame, prohibiting the use of standard Full Mortise hinges. Full Mortise only.

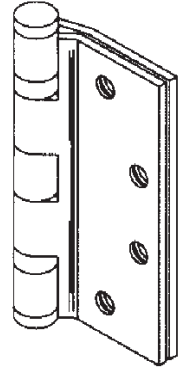

Single Acting Spring

UL listed. Adjustable Spring Tension. Available in Half Surface

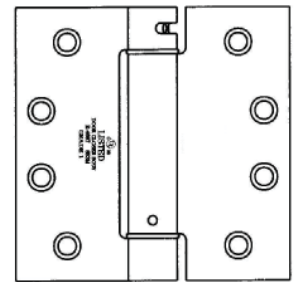

Double Acting Spring

Permits doors to open in either direction and automatically return to closed position. Adjustable spring tension.

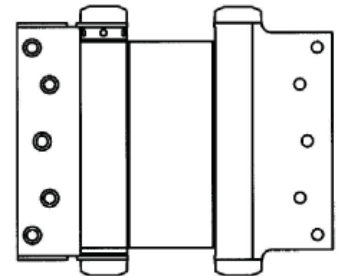

Floor Hinge

Double acting. Hold open in both directions. Mounts into cut out at bottom of door with top pivot at top corner of door.

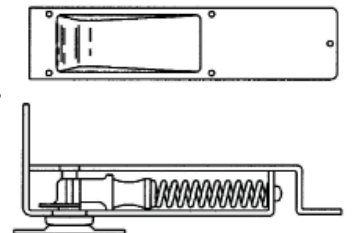

Pivots

Spring & Gravity
See page 7 for descriptions and prices.

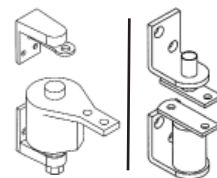

Invisible

See page 6 for pricing and details.

